

12V

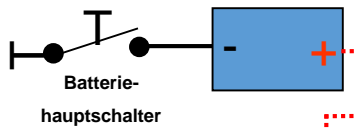

- Blinker 21W l. gelb
- Blinker 21W r. grün
- Licht 5W schwarz
- Bremse 21W l. rot
- Bremse 21W r. braun
- Licht Anhänger weiss
- Bremse Anhänger blau

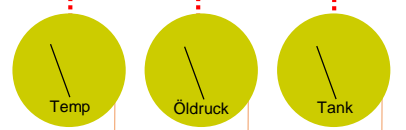
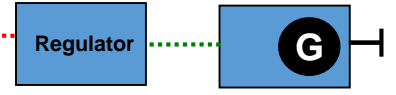
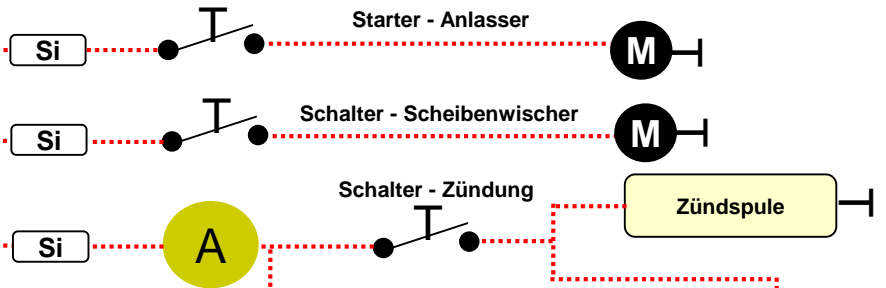

Temperatur-geber Öldruck-schalter Tankgeber

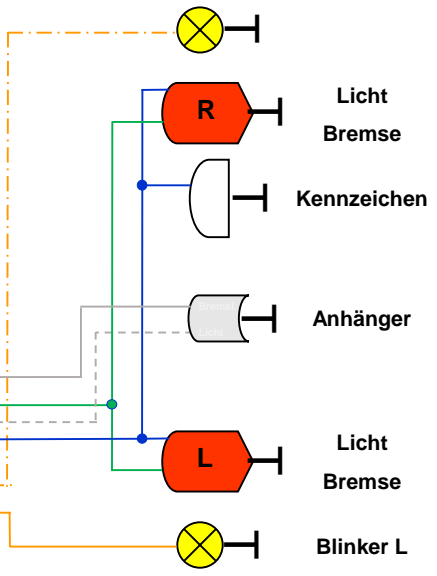
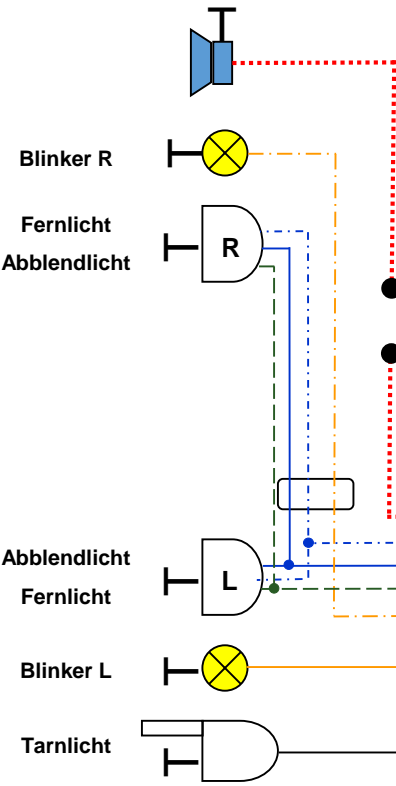
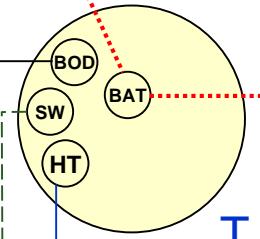
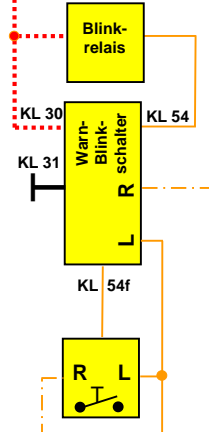

- (SW) Standlicht Schalterstellung: Stop LT
- (HT) Abblend- Fernlicht Schalterstellung: HD LTS
- (BOD) Tarnlichtscheinwerfer Schalterstellung: BO DR

Schaltbild neu 12 Volt ohne Oldtimerschaltung